



# Installation instructions, accessories

Volvo Car Corporation Gothenburg, Sweden

Instruction No	Version	Part. No.
31399535	1.0	31373832

## Electric engine heater, 110 V



IMG-378205



# Installation instructions, accessories

Volvo Car Corporation Gothenburg, Sweden

## Materials

Designation	Part number
soap solution	
Low temperature grease	1161427

## Equipment

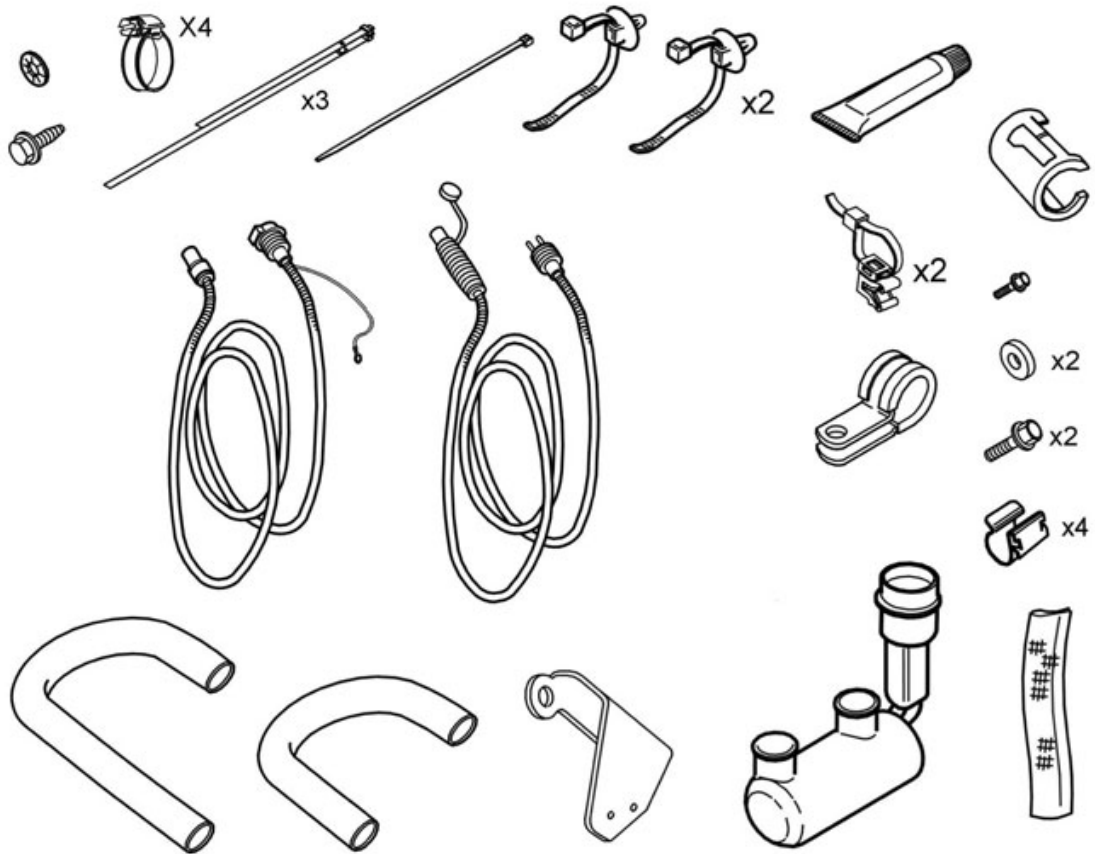
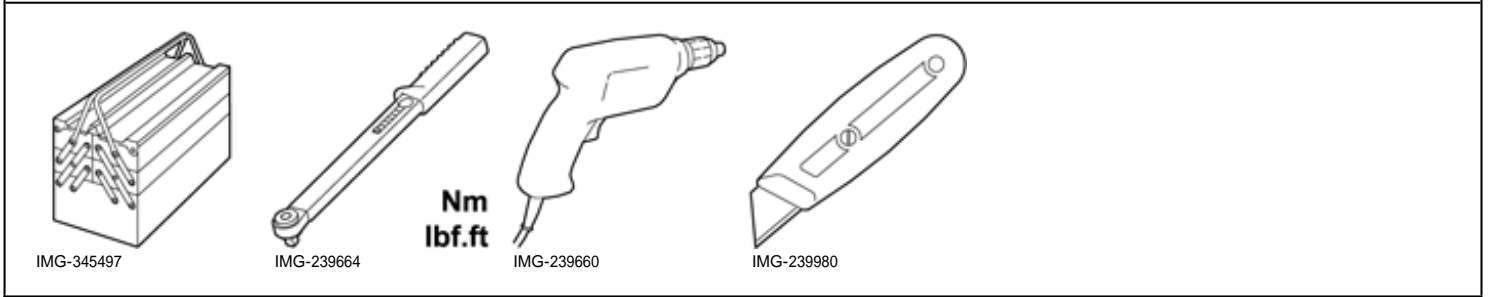

IMG-372716



# Installation instructions, accessories

Volvo Car Corporation Gothenburg, Sweden

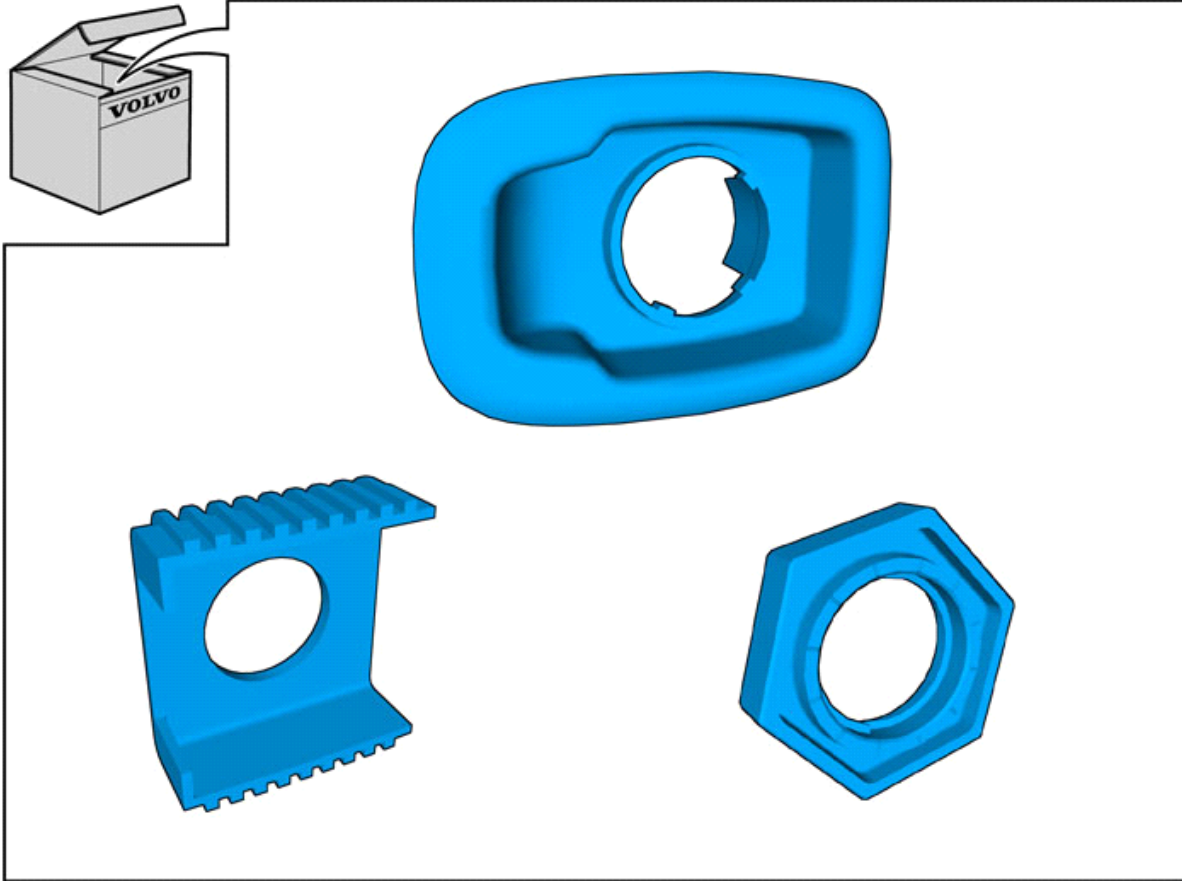

IMG-351403



# Installation instructions, accessories

Volvo Car Corporation Gothenburg, Sweden

S60 (11-) 2014-  
V60 2014-

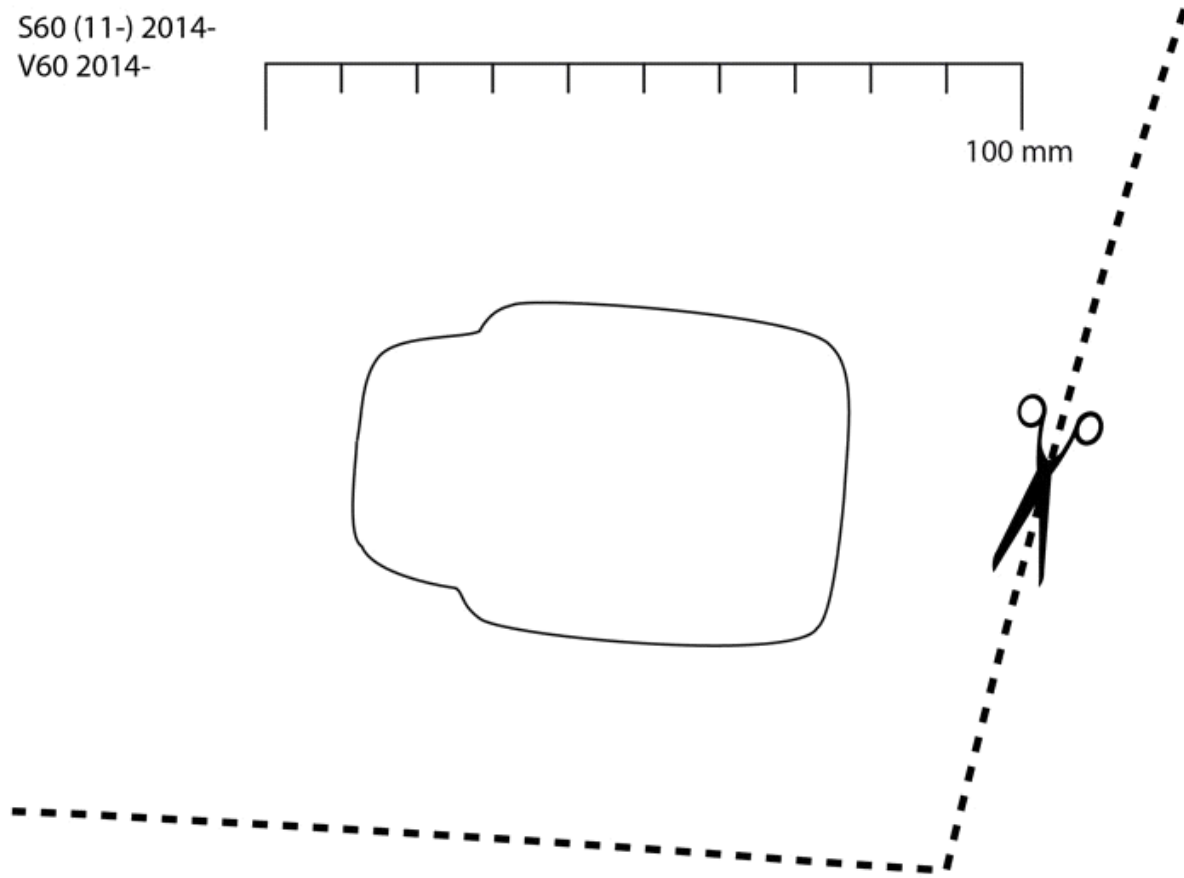

IMG-378047



# Installation instructions, accessories

Volvo Car Corporation Gothenburg, Sweden

---

## Information

---

1

Read through all of the instructions before starting installation.

Notifications and warning texts are for your safety and to minimise the risk of something breaking during installation.

Ensure that all tools stated in the instructions are available before starting installation.

Certain steps in the instructions are only presented in the form of images. Explanatory text is also given for more complicated steps.

In the event of any problems with the instructions or the accessory, contact your local Volvo dealer.

---

## Color symbols

---

2

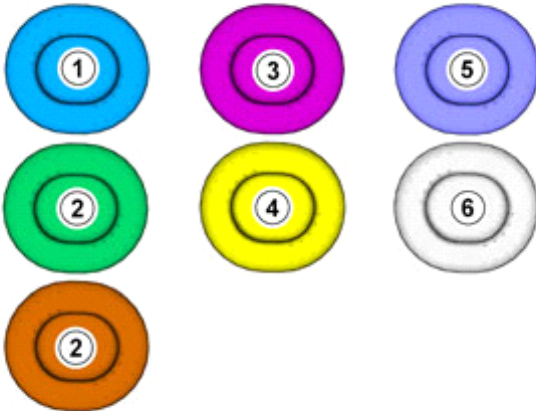

IMG-363036

### Note!

This colour chart displays (in colour print and electronic version) the importance of the different colours used in the images of the method steps.

1. Used for focused component, the component with which you will do something.
2. Used as extra colors when you need to show or differentiate additional parts.
3. Used for attachments that are to be removed/installed. May be screws, clips, connectors, etc.
4. Used when the component is not fully removed from the vehicle but only hung to the side.
5. Used for standard tools and special tools.
6. Used as background color for vehicle components.

---

## Removal

---



# Installation instructions, accessories

Volvo Car Corporation Gothenburg, Sweden

3

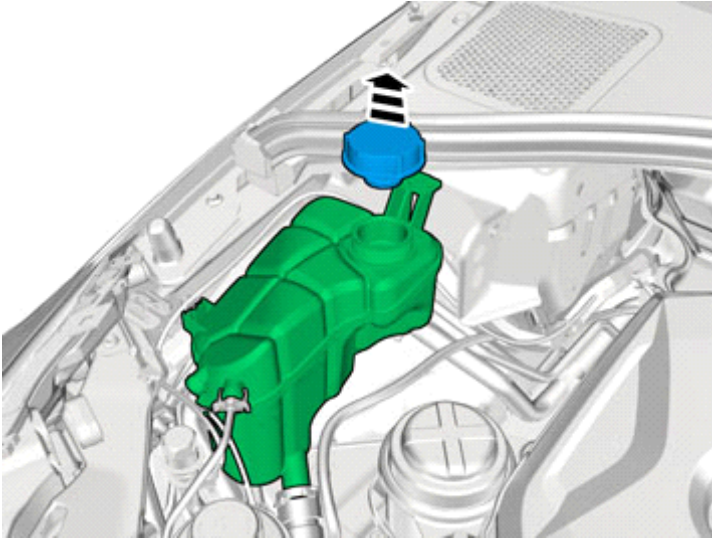

IMG-351277

4

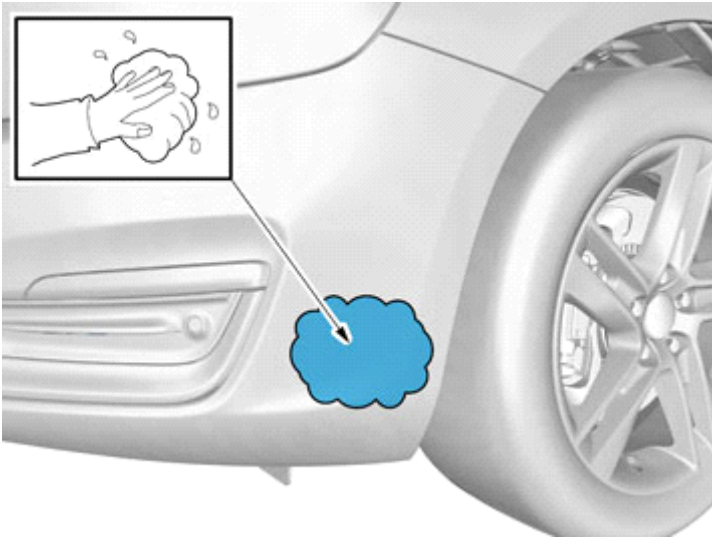

IMG-378206

Clean the Bumper Cover surface.

**Use:** , soap solution

5

S60 (11-) 2014-  
V60 2014-

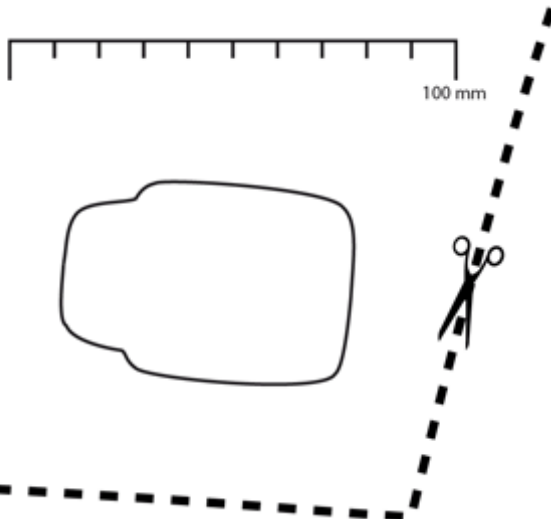

IMG-378210

Use the template in the installation instructions.



# Installation instructions, accessories

Volvo Car Corporation Gothenburg, Sweden

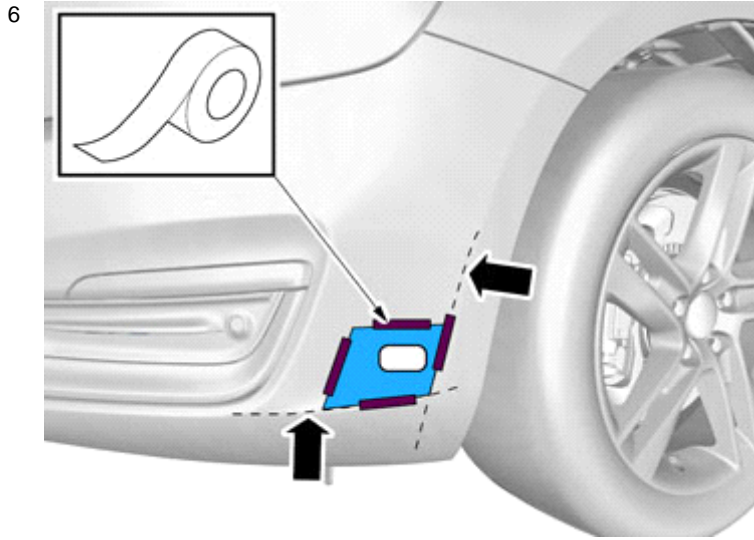

IMG-378213

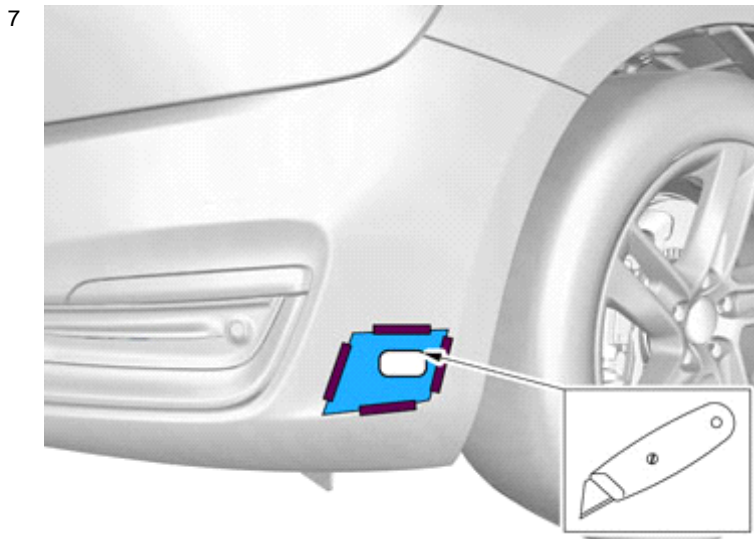

IMG-378214

**Caution!**  
Cut carefully to avoid unintentional damage or personal injury.

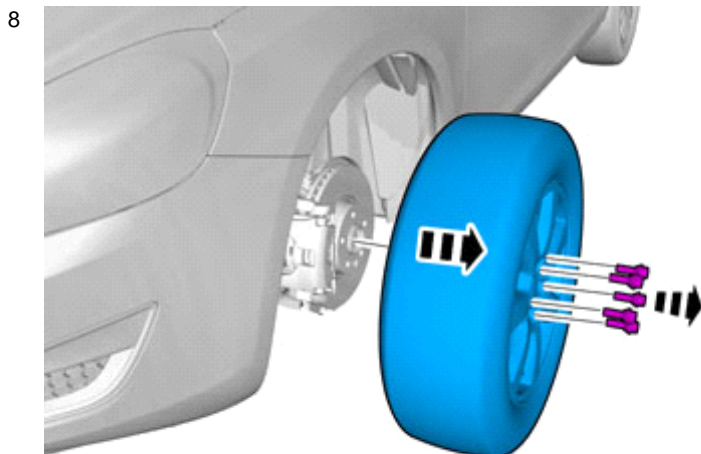

IMG-352021





# Installation instructions, accessories

Volvo Car Corporation Gothenburg, Sweden

9

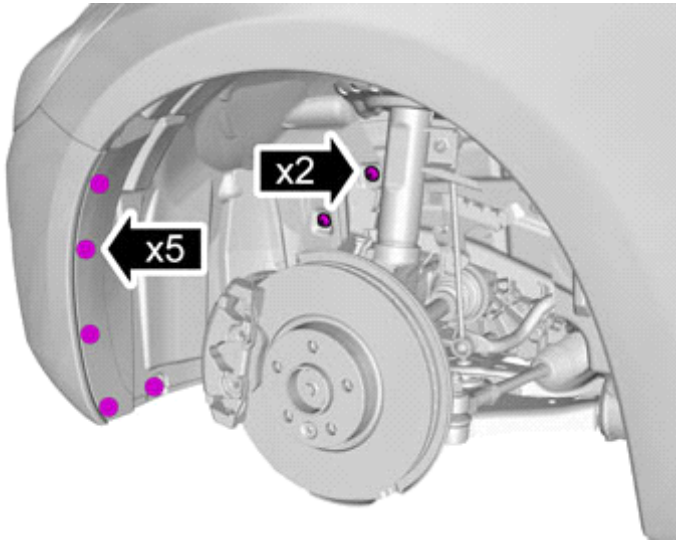

IMG-352031

Remove the screws.

Remove the nuts.

10

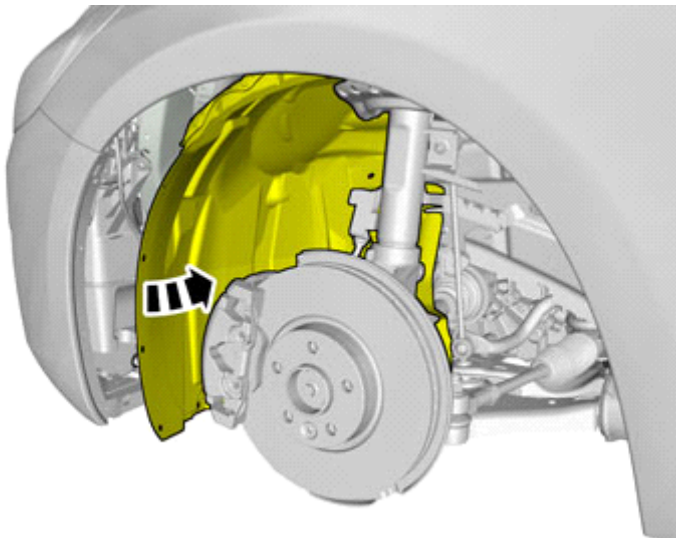

IMG-352036

Fold the wing liner to one side.

**Accessory installation**





# Installation instructions, accessories

Volvo Car Corporation Gothenburg, Sweden

11

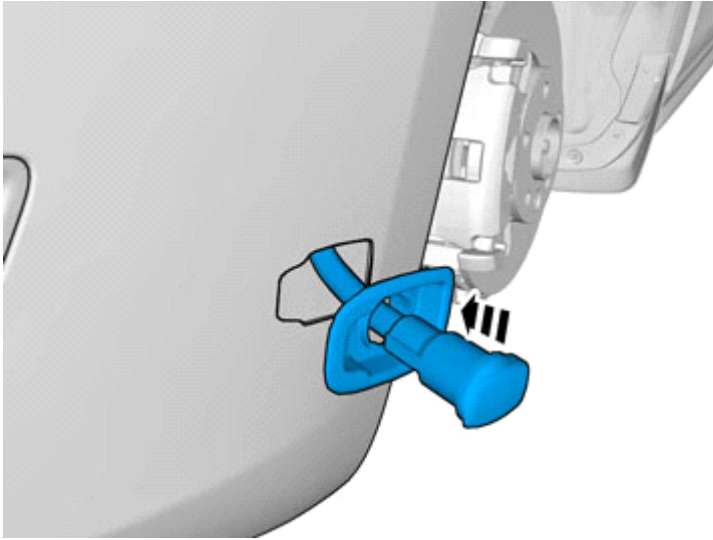

IMG-351436

Install component that comes with the accessory kit.

Pull the wiring through.

12

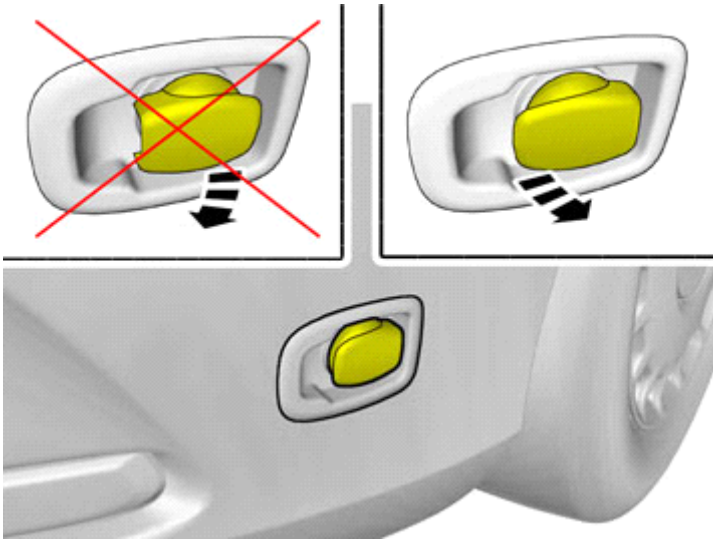

IMG-363401

**Note!**

Note the position.

13

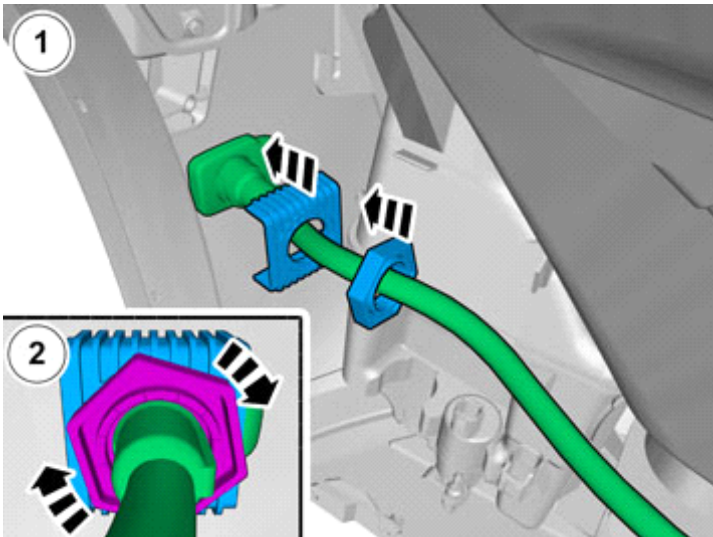

IMG-351416

Install component that comes with the accessory kit.



# Installation instructions, accessories

Volvo Car Corporation Gothenburg, Sweden

14

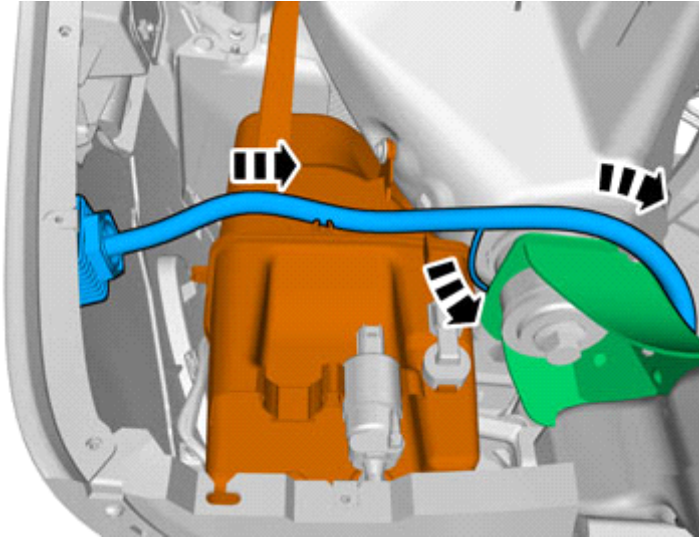

IMG-351696

## Removal

15

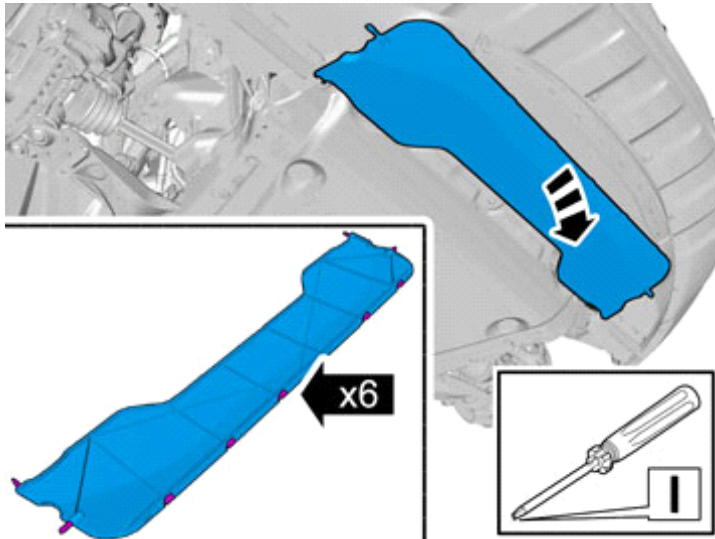

IMG-351435

Remove the panel.



# Installation instructions, accessories

Volvo Car Corporation Gothenburg, Sweden

16

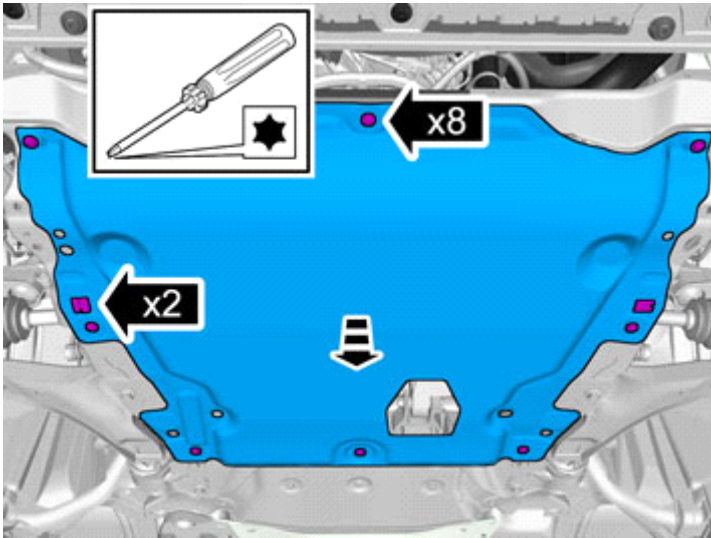

IMG-351437

Remove the screws.

Remove the clips.

Remove the panel.

## Accessory installation

17

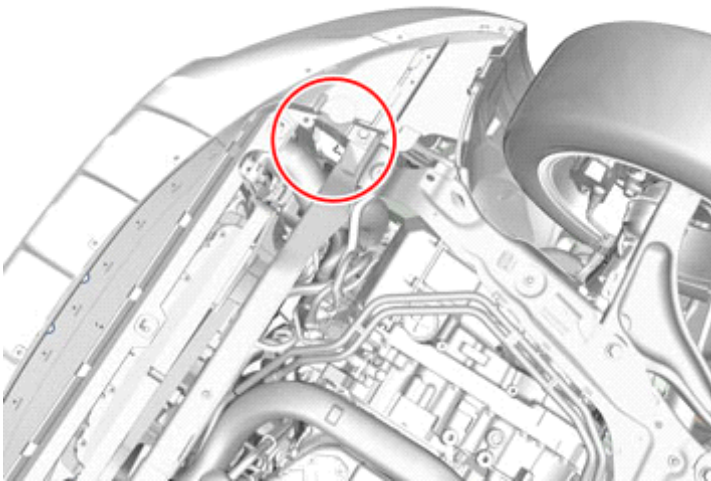

IMG-372832

**Note!**  
Orientation view



# Installation instructions, accessories

Volvo Car Corporation Gothenburg, Sweden

18

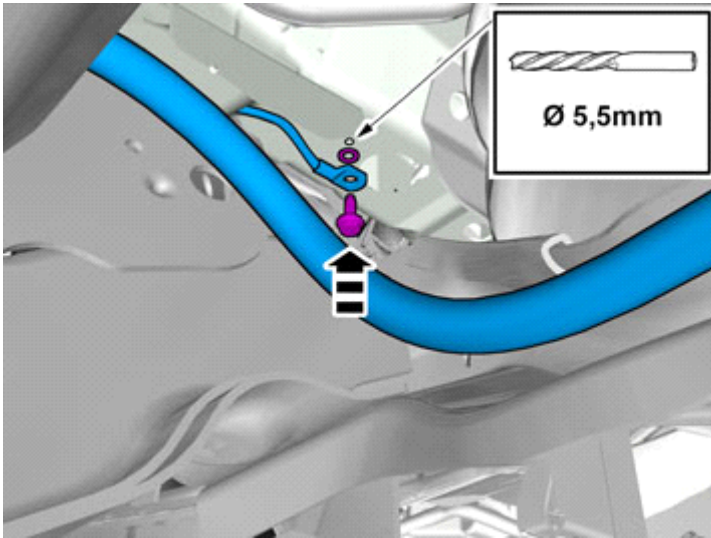

IMG-372825

Install the screw.

**Tightening torque:** M6 , 10 Nm

19

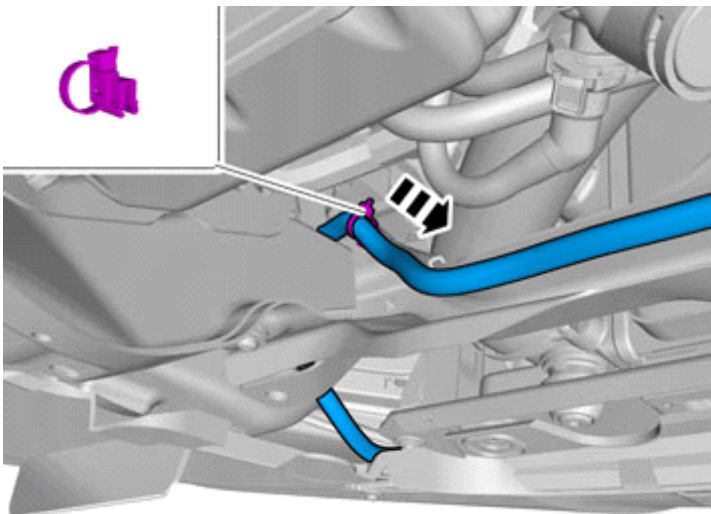

IMG-343163

Pull the wiring through.

Install a clips onto the upper edge of the subframe.

## Removal



# Installation instructions, accessories

Volvo Car Corporation Gothenburg, Sweden

20

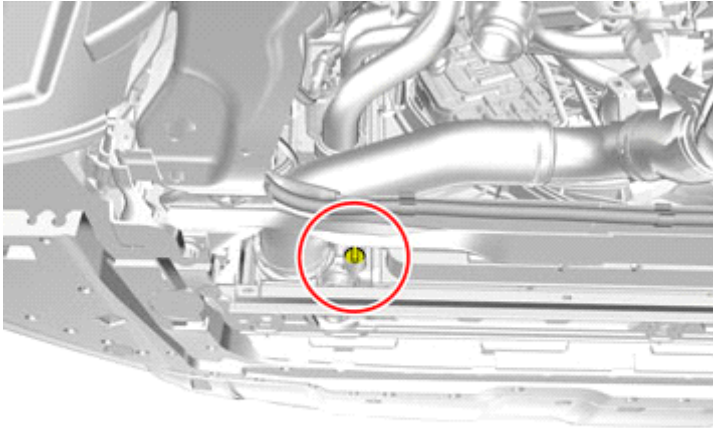

**Note!**  
Orientation view

IMG-372767

21

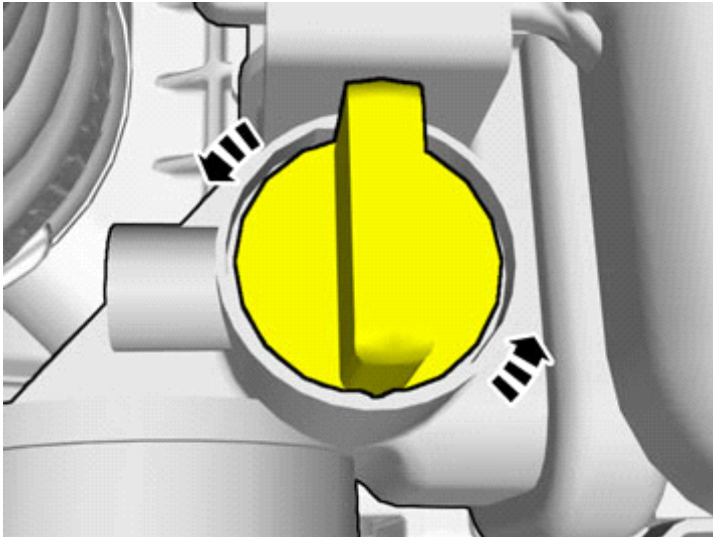

IMG-371658

**Note!**  
Close the drain cock after the coolant has drained.

Place a container under the car.

Drain the coolant.

## Accessory installation





# Installation instructions, accessories

Volvo Car Corporation Gothenburg, Sweden

22

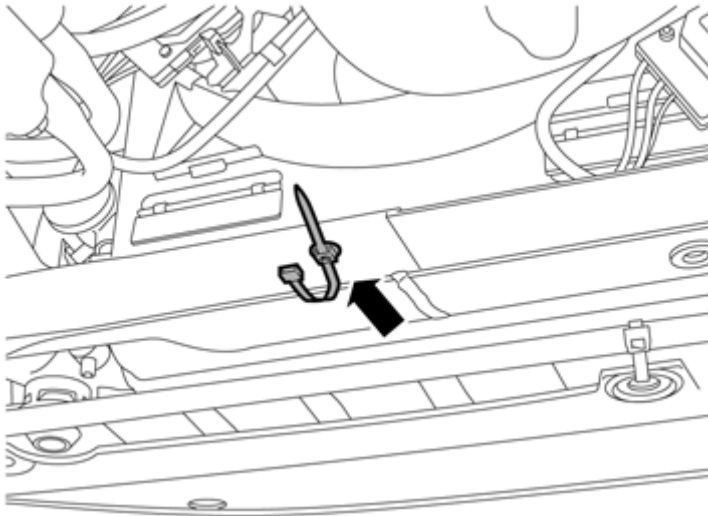

IMG-317737

Install the clip(s).

23

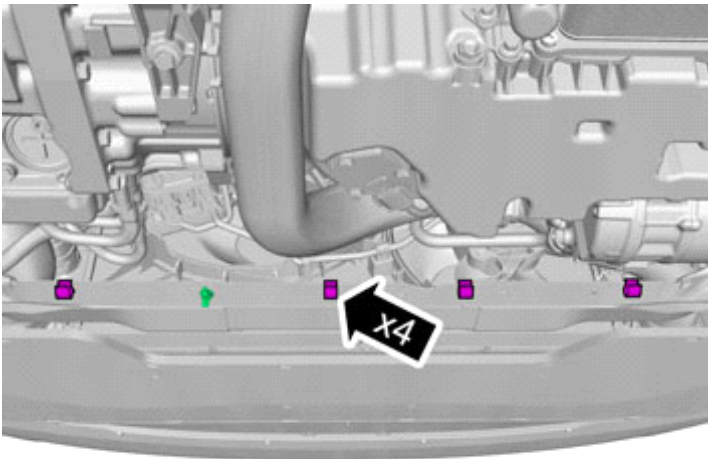

IMG-344611

Install a clips onto the upper edge of the subframe.

24

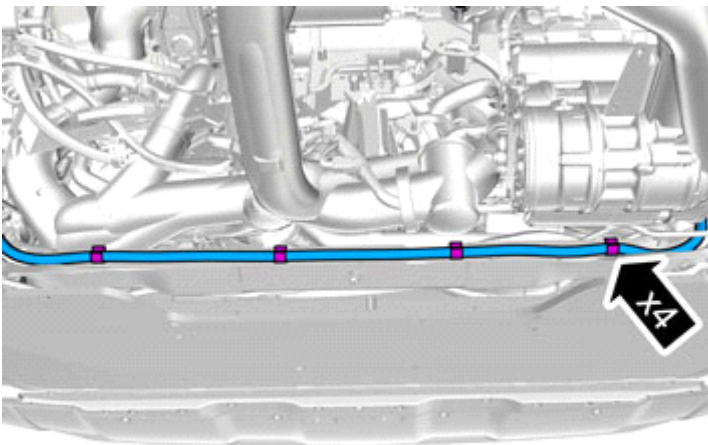

IMG-372707

Secure the cable with clips in the subframe flange.



# Installation instructions, accessories

Volvo Car Corporation Gothenburg, Sweden

25

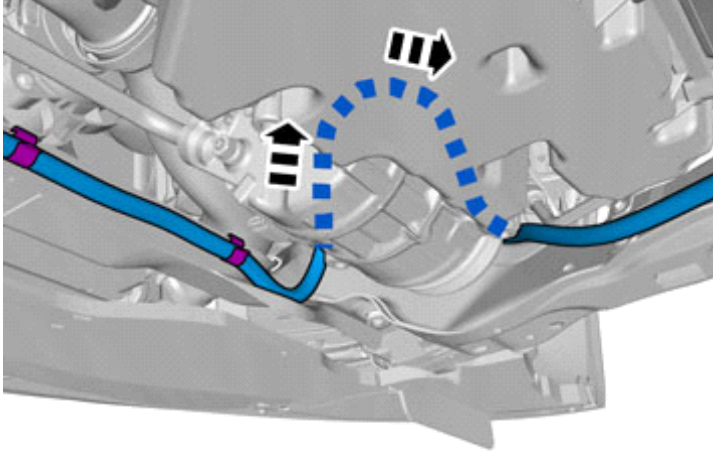

Pull the wiring through.

IMG-342111

26

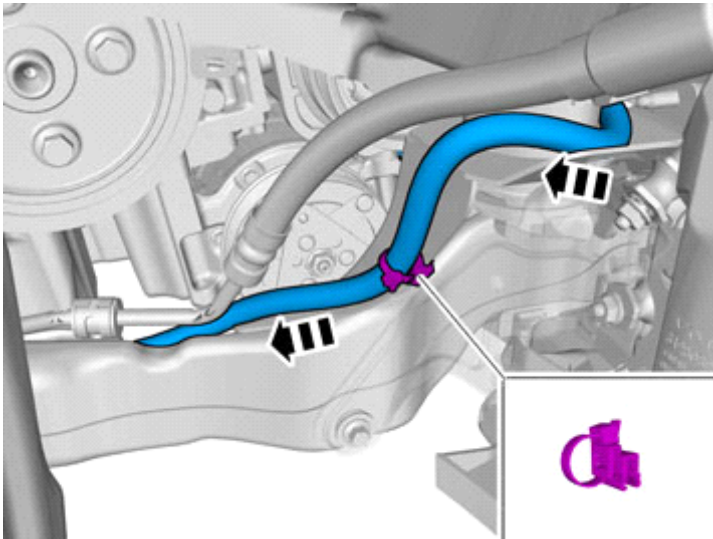

Secure the cable with clips in the subframe flange.

IMG-342112

27

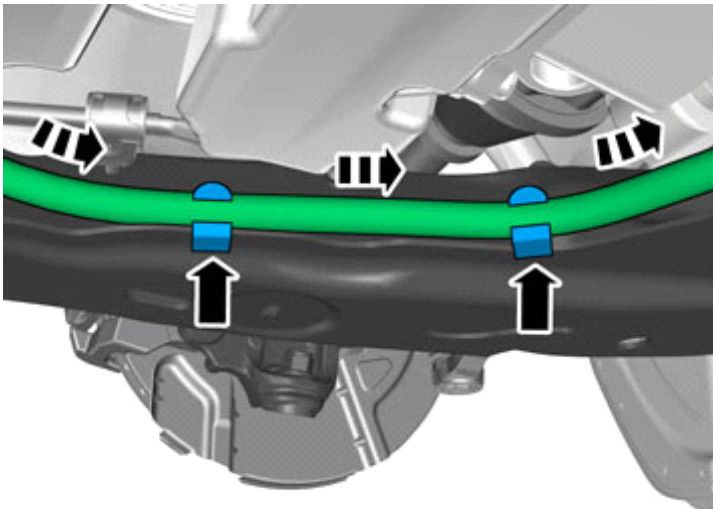

Secure the cable with clips in the subframe flange.

IMG-359904





# Installation instructions, accessories

Volvo Car Corporation Gothenburg, Sweden

28

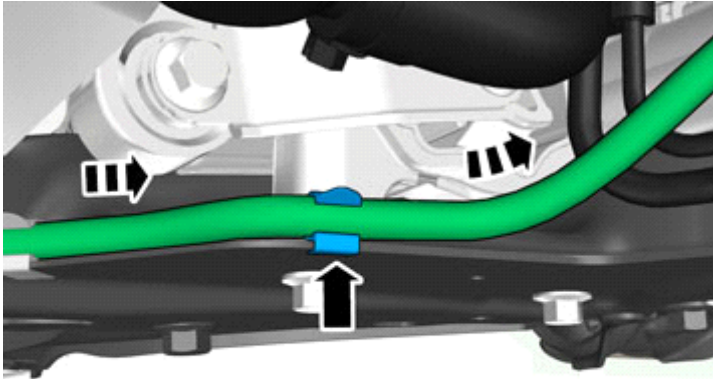

Secure the cable with clips in the subframe flange.

IMG-360369

29

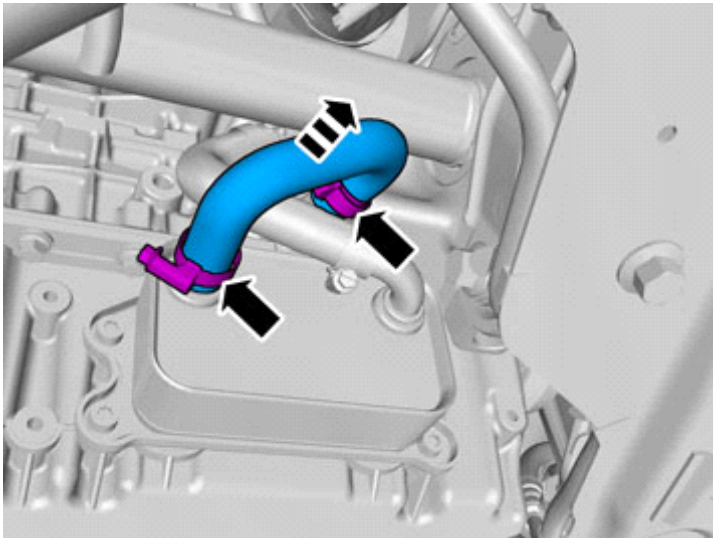

**Warning!**

Be prepared to collect escaping fluid.

Loosen the hose clamps.

Remove the hose.

The part is not to be reused.

IMG-343158



# Installation instructions, accessories

Volvo Car Corporation Gothenburg, Sweden

30

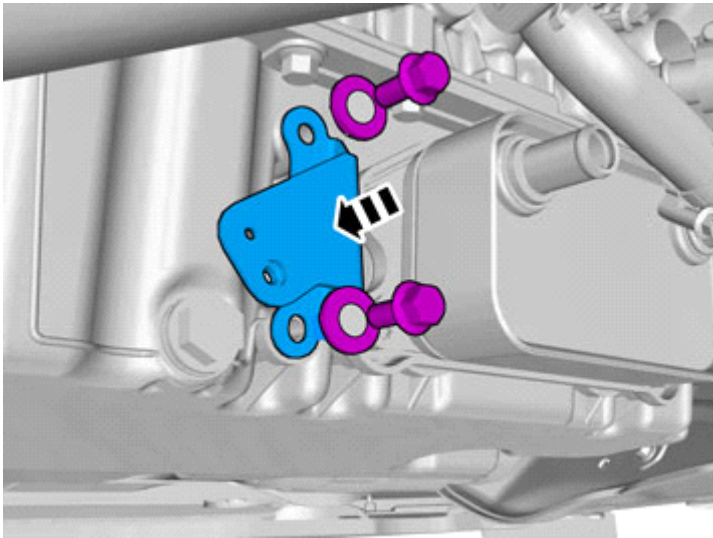

IMG-343162

Install component that comes with the accessory kit.

Install the screws.

31

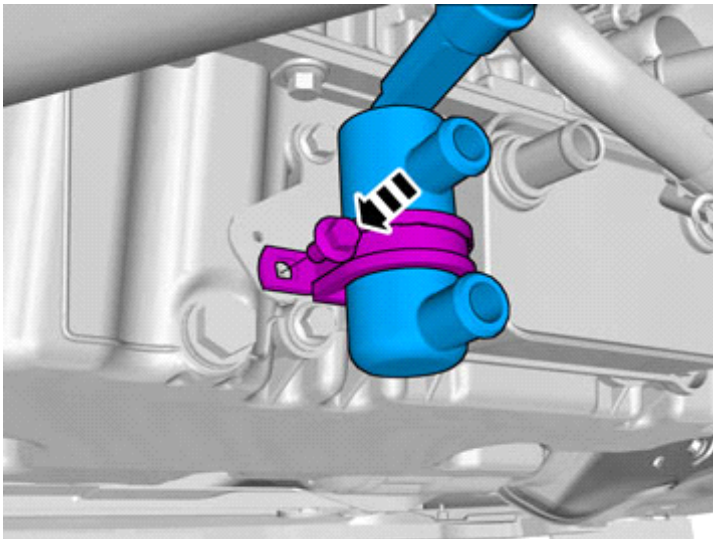

IMG-343168

**Note!**

The hose connections on the heater must face backward.

Install component that comes with the accessory kit.

Install the screw.

32

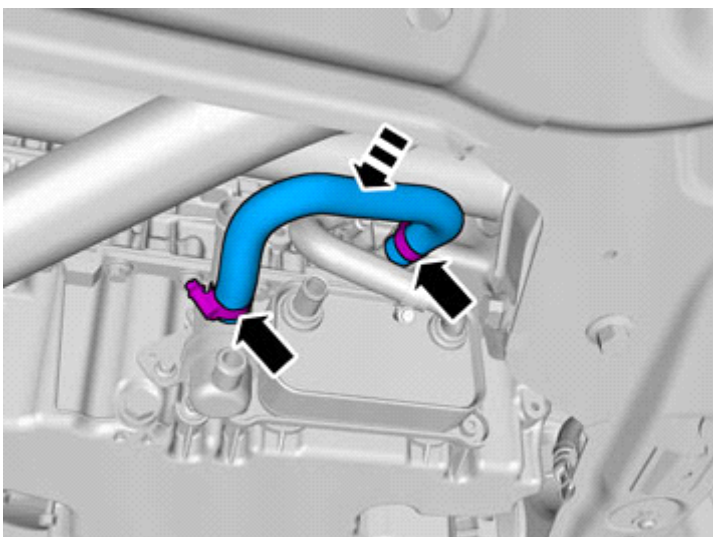

IMG-343166

Install component that comes with the accessory kit.

Install the hose.

Tighten the hose clamps.



# Installation instructions, accessories

Volvo Car Corporation Gothenburg, Sweden

33

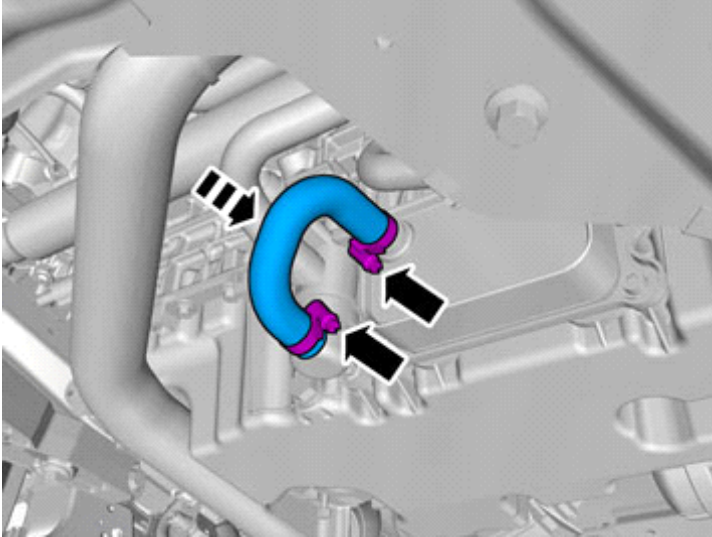

IMG-343165

Install component that comes with the accessory kit.

Install the hose.

Tighten the hose clamps.

34

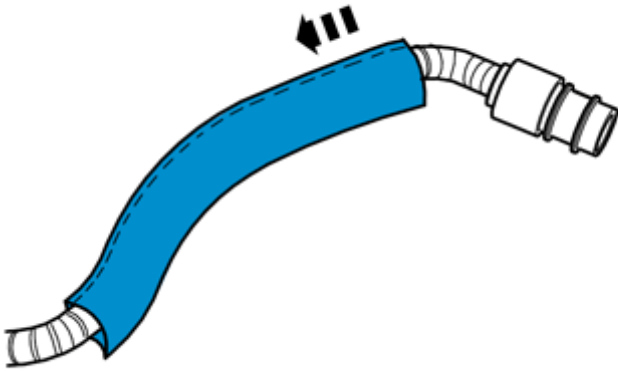

IMG-352077

Install component that comes with the accessory kit.

35

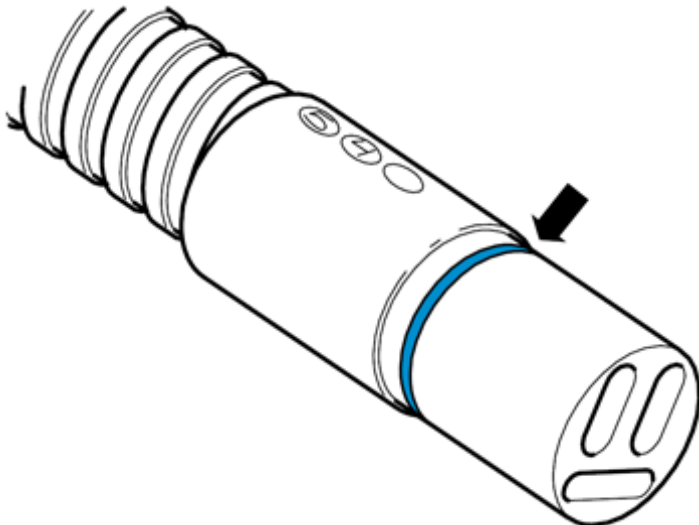

IMG-352076

**Caution!**

No grease on contact surfaces.

Lubricate the O-ring.

**Use:** 1161427, Low temperature grease



# Installation instructions, accessories

Volvo Car Corporation Gothenburg, Sweden

36

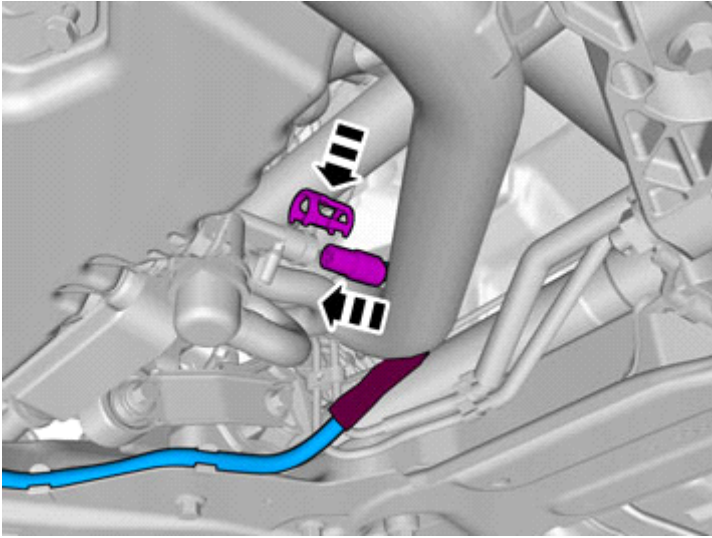

IMG-343164

Connect the cable harness.

Install the clip(s).

37

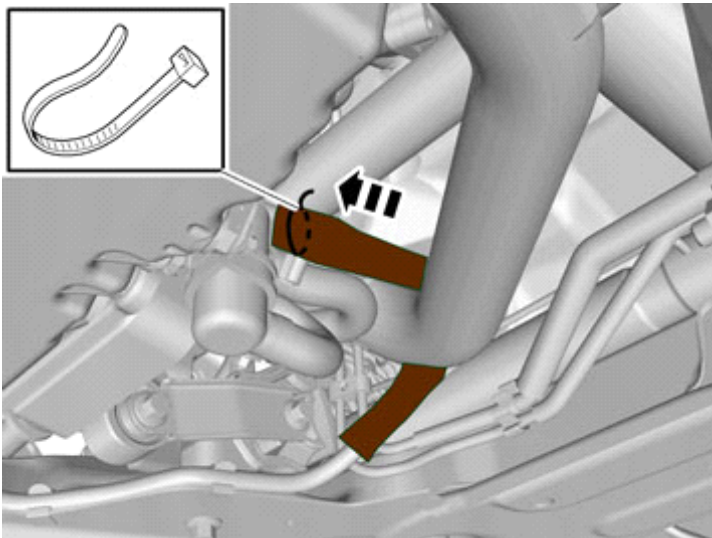

IMG-343161

Clamp using the grey cable tie.



# Installation instructions, accessories

Volvo Car Corporation Gothenburg, Sweden

38

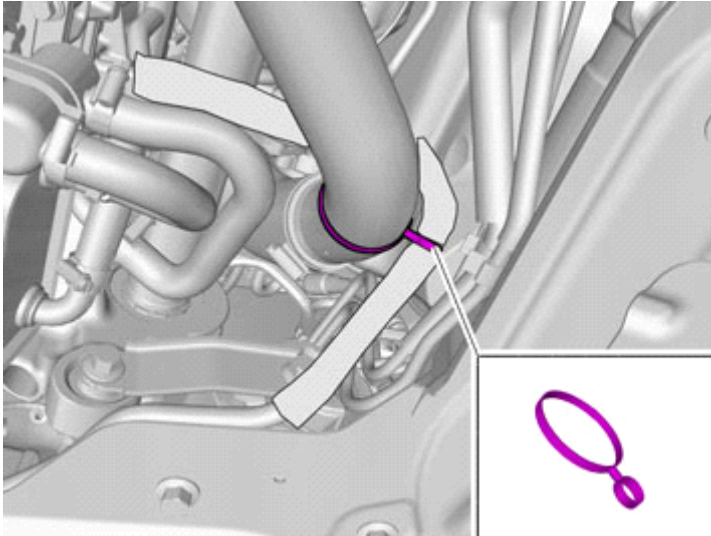

IMG-347412

Install the cable.

## Installation

39

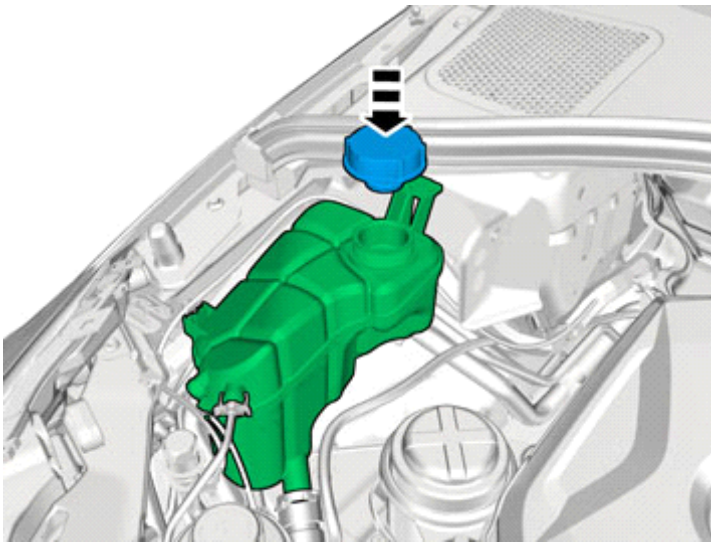

IMG-352094

### Caution!

Do not clamp the wire onto brake line or fuel line or power steering hose, or similar.

### Caution!

Make sure to locate the wiring in such a way that any damage caused by heat or excessive wear is avoided.

Clamp the cables and connectors to the existing cables to prevent noise.

Reinstall the removed parts in reverse order.

Fill with coolant and run the engine to operating temperature.

Vent the cooling system and check for leakage.

Post-fill the cooling system if necessary.